

## 水槽 KE - R15 Vintage Gun Metal



水槽

代码: 2156 086



### 细节

表面处理 PVD

---

质地 Vintage

---

边型和安装方式 平嵌

---

材料 AISI 304 不锈钢

---

染色 Gun Metal

---

底座 45 cm

---

尺寸 440x440 mm

---

标准配件 固定钩, 垫圈, 下水器, 溢水口和虹吸管, 纸板盒包装

---

龙头孔 无定位孔

---

安装孔 [View technical data sheet](#)

---

下水器 否

---

宽 44 cm

---

盆内尺寸 400x400mm

---

单槽/双槽 单槽

---

下水组件 3,5" 下水器

---

## 特点

**枪黑色** Gun  
Metal表面处理是通过采用称为PVD（物理气相沉积）的物理工艺处理钢而获得的，该工艺将贵金属颗粒沉积在表面上，从而具有独特着色，并改善了钢的机械性能，从而更耐冲击和耐刮擦。

---

**高厚度** 1mm厚的钢。相当大的厚度，保证了最大的坚固性和耐用性。

---

**3.5" 下水器提篮** Foster®水槽均配备了3.5"下水器，有可防止固体颗粒流入下水器的实用篮式塞。3.5"下水器允许使用Foster®碎渣机，可与所有型号兼容。

---

**溢水口** 溢水口是Foster水槽上的一项安全措施，可以防止疏忽时水的溢出。方形溢水解决方案，具有简约的方形，更加美观大方。

---

**小倒角** 具有现代设计和更大容量的方形碗，具有最小的美观性和极高的实用性。

---

**老式PVD** 久负盛名的PVD表面处理与对Vintage表面处理细节的关注相结合，创造出独特的优雅感。

---

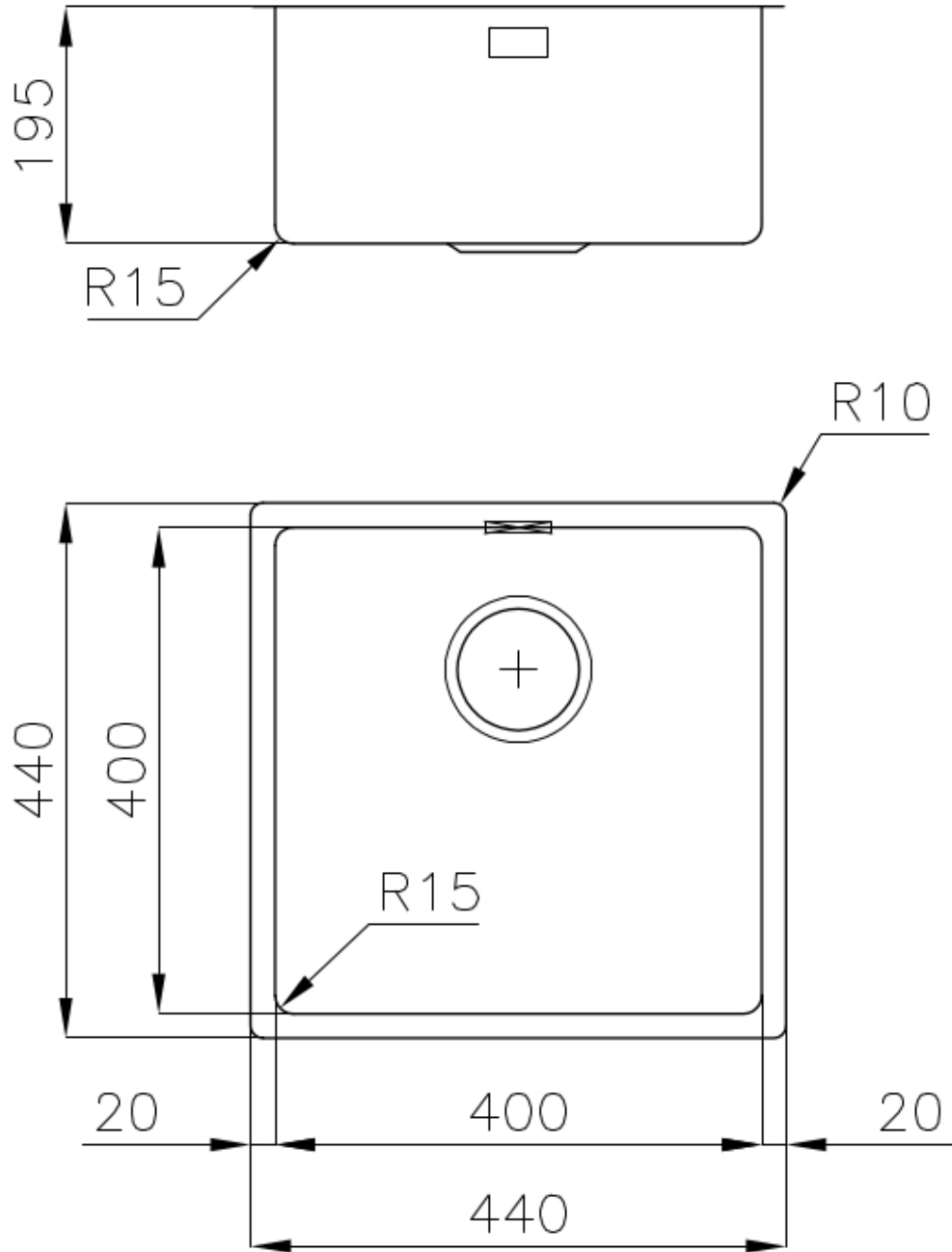

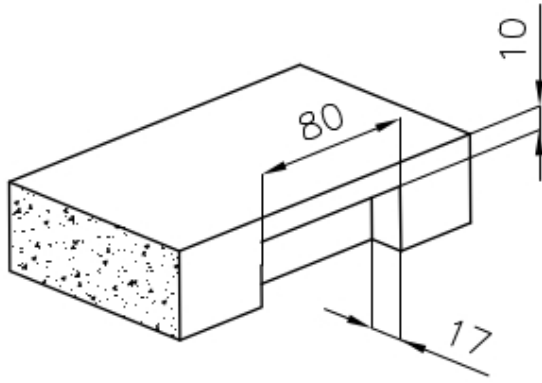

Intaglio per il troppo-pieno  
Recess for housing the over-flow

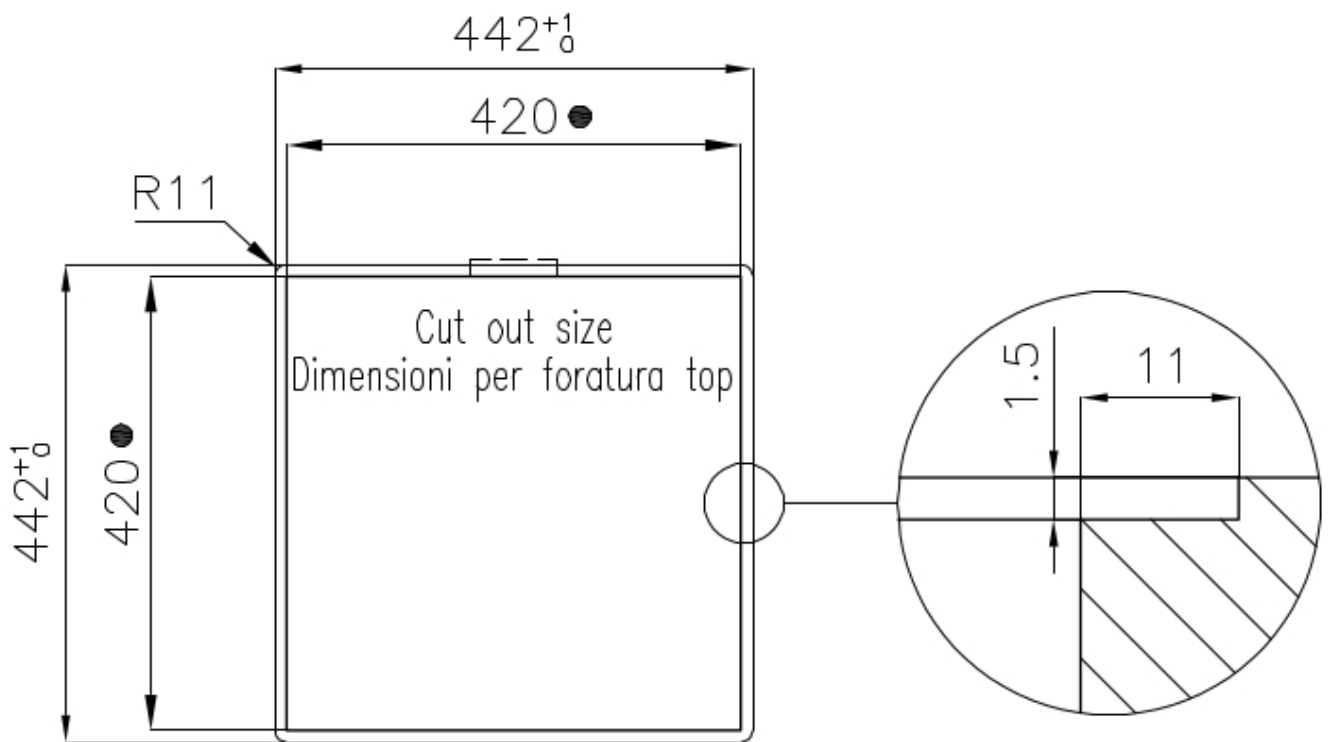

- Built-in cut out for FTS – Foratura per installazione FTS



## OPTIONAL ACCESSORIES



**HPDE Twin 砧板**  
8644 101



**HPDE 砧板**  
8657 001



**不锈钢爪篱**  
8154 000



**不锈钢篮**  
8612 000



**不锈钢背板**  
8100 154

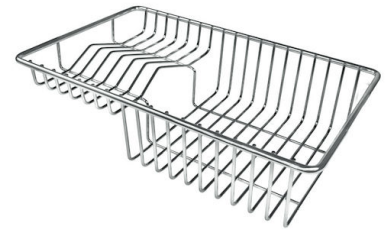

**不锈钢背板**  
8100 303  
\* 仅与附件结合使用 8644 101

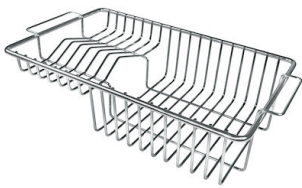

**不锈钢背板**  
8100 201



**玻璃砧板**  
8631 300



**白托盘**  
8153 100

## RECOMMENDED PAIRINGS



龙头 Bert  
8428 100



龙头 KE  
8492 000

## OPTIONAL AUTOMATIC WASTE FITTINGS



自动下水器 枪黑色  
8407 110